



# MOISTURE ENCOUNTER MEX5



- MEX5 -

## USER GUIDE

NOTE: This user guide is for the MEX5 version V2.0. To check which version meter you have, press the  button,  to select SETTINGS,  to select INFORMATION. Version V2.0 meters will say Firmware Version V2.0.

## TABLE OF CONTENTS

<b>Introduction</b> .....	4
- <a href="#">Non-destructive test (NDT) mode</a> .....	4
- <a href="#">Pin Probe mode</a> .....	4
- <a href="#">Hygrometer / Psychrometrics mode</a> .....	4
- <a href="#">In-Situ Equilibrium Relative Humidity Probe mode</a> .....	4
- <a href="#">Settings &amp; Advanced Features</a> .....	5
 <b>How the MEX5 works - Overview</b>	
- <a href="#">Non-destructive testing, Scales and Sensitivity, Shallow-Depth Functionality</a> .....	6
- <a href="#">Pin Probe, Building Materials, Wood Species, WME (Wood Moisture Equivalent)</a> .....	6-7
- <a href="#">Psychrometrics and Built-in ambient Hygrometer</a> .....	7
- <a href="#">In-Situ Equilibrium Relative Humidity Probe</a> .....	7
 <b>Operating Instructions - Overview</b> .....	8
- <a href="#">Quick Start Operating Instructions</a> .....	9
- <a href="#">Non-destructive testing (NDT)</a> .....	10
- <a href="#">Pin Probe</a> .....	12
- <a href="#">Psychrometrics</a> .....	14
- <a href="#">In-situ Equilibrium Relative Humidity</a> .....	14
- <a href="#">Settings</a> .....	15
• <a href="#">Advanced Features</a>	
- <a href="#">Baseline Reference</a> .....	15
- <a href="#">Specific Gravity of Wood</a> .....	15
- <a href="#">Surface Temperature</a> .....	15
- <a href="#">Pin Temperature Correction</a> .....	16
- <a href="#">Pin EMC (Expected Moisture Content)</a> .....	16
• <a href="#">Buzzer</a> .....	16
• <a href="#">C°/F° and GPP or g/kg choice</a> .....	16
• <a href="#">Backlight timeout</a> .....	16
• <a href="#">Language</a> .....	16
 <b>Non-Destructive Testing Measurement Mode Guide</b> .....	17
- <a href="#">Wood Scale Guide</a> .....	18
• <a href="#">Introduction</a> .....	18
• <a href="#">Using the Wood Scale</a> .....	18
• <a href="#">Relative Humidity &amp; Moisture Content</a> .....	19
• <a href="#">Specific Gravity</a> .....	20
• <a href="#">Table of Wood Specific Gravities (SG)</a> .....	21
- <a href="#">Shallow Depth Scale Guide</a> .....	22
• <a href="#">Using the Wood scale alongside the Shallow-Depth scale for Wood</a> .....	22
• <a href="#">Flooring with Wood &amp; Shallow-Depth Scale</a> .....	23
- <a href="#">Drywall - Roofing Scale Guide</a> .....	24-25
- <a href="#">Plaster - Tile Scale Guide</a> .....	26
- <a href="#">Masonry Scale Guide</a> .....	27

**TABLE OF CONTENTS**

**Pin Probe Mode Guide**.....28

- [Pin Probe Menu Selections](#) .....28
  - [Building Materials \(Wood, Drywall, OSB, Plywood, Gypcrete\)](#).....28
  - [Wood Species](#).....28
  - [WME](#).....28
  - [Calibration Check](#) .....28
- [Factors Affecting Moisture Readings In Wood](#).....29
- [Pin Moisture Readings and Wood Flooring](#).....30
- [Pin Temperature Correction](#).....30
- [Humidity and Moisture Content Relationship](#).....31

**Psychrometrics Mode Guide**.....32

- [Delta T Temperature](#).....32
- [Surface Temperature](#).....32
- [Thermal Hygrometer and Enthalpy](#).....33

**In-Situ Equilibrium Relative Humidity Probe Mode Guide**.....34

- [Building Envelope In-Situ Equilibrium Relative Humidity](#).....34
- [Concrete In-situ Equilibrium Relative Humidity](#).....34-38
- [Calibration Check Salts](#).....39

**Limitations**.....40

**Calibration**.....40

**Warranty**.....40

**Product Development**.....41

**Safety**.....41

**Wood Species Correction Charts**.....42-53

## INTRODUCTION

Thank you for trusting our brand and choosing the Moisture Encounter MEX5 from Tramex. It is our goal to ensure that you are always happy with your Tramex products, so please let us know if you have any questions and rest assured, we are always here to help.

**NOTE: This user guide is for the MEX5 version V2.0. To check which version meter you have, press the  button,  to select SETTINGS,  to select INFORMATION. Version V2.0 meters will say Firmware Version V2.0.**

The Moisture Encounter MEX5 employs advanced digital technology to enable the incorporation of 4 measurement modes, and a number of Advanced Features to select from, all displayed on a large, clear easy-to-read digital display: 2.3" x 1.4" (58mm x 35mm).

### 1. Non-destructive test (NDT) mode

The Moisture Encounter MEX5 enables dual-depth, non-invasive moisture measurement of %MC Moisture Content in wood. The comparative scales (or relative, REL) have different ranges of sensitivity that are appropriate to materials of different densities. These are used for moisture readings in wood by-products and a wide range of building materials including drywall, roofing, plaster, tiles and masonry. The shallow depth mode can also be used for comparative readings for these materials.

### 2. Pin Probe mode (optional plug-in probe)

The Moisture Encounter MEX5 becomes a pin-type meter utilising resistance to measure the percentage moisture content (%MC) of wood when used with the optional plug-in Pin Probe meter. A wide variety of wood species can be selected. Pin Probe mode can also be used for Drywall, OSB, Plywood and Gypcrete %MC and WME (Wood Moisture Equivalent) readings for other materials.

### 3. Hygrometer/ Psychrometrics mode

The Moisture Encounter MEX5 uses its built-in hygrometer that measures the ambient relative humidity (RH), ambient temperature (Ta), dew point temperature (Td) and humidity ratio (GPP, g/kg) of the environment. These measurements are shown at the bottom of the screen for each mode or scale being used. In Psychrometrics mode the DELTA T temperature value (difference between the ambient temperature and the dew point temperature). The surface temperature, and Enthalpy value (the measurement of energy in a thermodynamic system) can also be viewed.

### 4. In-Situ Equilibrium & Ambient Relative Humidity mode (optional plug-in probe)

Using the optional plug-in Hygro-i2 RH probes, the Moisture Encounter MEX5 will measure In-Situ Relative Humidity, Temperature, Dew Point and Specific Humidity within structural materials, insulation or internal air spaces. A structural material such as a concrete slab can be tested using the in-situ method or RH Hood methods (International Standards: ASTM F2170 & BS 8201, 8203, 5325). Relative Humidity Probes can also be used for RH measurements within air spaces in the building envelope.

## 5. Settings & Advanced Features

In Settings, choose to turn on/off the backlight timeout and high reading buzzer alert, as well as choose between language and Fahrenheit and Celcius preferences.

The MEX5 incorporates a number of advanced features such as:

- 'Baseline' reference reading for the non-destructive scales is comparable to a 'known dry reading' or 'dry standard reading'. The MEX5 can be set to show how far or close the readings are to that 'drying goal'.
- Specific Gravity of Wood adjustment allows for adjustment of the sensitivity of the non-destructive readings to correlate to the density of the wood under test according to that wood.
- Surface Temperature thermometer provides surface temperature measurements from a built-in non-contact infrared thermometer on the base of the meter.
- Pin probe temperature correction will automatically adjust the %MC depending on the wood temperature to give more precision to the pin probe measurements.
- Pin probe EMC of Wood (Expected Moisture Content). The Expected Moisture Content option allows the meter to give an expected moisture content value based on the ambient temperature and relative humidity conditions.

## HOW THE MEX5 WORKS - Overview

**In Non-Destructive Testing (NDT) mode**, the instrument operates on the principle that the electrical impedance of a material varies in proportion to its moisture content.

To measure/detect moisture, the three coplanar conductive rubber electrodes mounted on the base of the instrument case are pressed onto the wood or material sample. The instrument measures the electrical impedance of the sample by creating a low frequency alternating electric field between the electrodes. This non-destructive field penetrates the material under test to a depth of approximately 30mm (1 ¼ inches), or 9 mm (¾ inch) in Shallow Depth mode. The very small alternating current flowing through the field is inversely proportional to the impedance of the material. The instrument detects this current, determines its amplitude and thus derives the moisture value.

### NDT Scales and Sensitivity

The Moisture Encounter MEX5 measures moisture content and conditions with non-destructive, material-specific scales designed and calibrated for wood, drywall, plaster, tile, roofing and masonry.

Scales for Wood and Shallow Depth Wood, when used with wood, will give a %MC reading between 0 and 30% MC.

Scales for other materials have a preset sensitivity appropriate to the density of the materials indicated, and give a comparative (relative, REL 0-99) reading. These scales are not exclusive to the materials named. If the sensitivity of a selected scale allows for meaningful comparative readings appropriate to the density of the material under test, that scale can be used.

The Drywall-Roofing scale is the most sensitive for less dense materials; the Plaster-Tile scale is mid-sensitive; and the Masonry scale is the least sensitive for more dense materials.

### NDT Shallow-depth functionality

The Moisture Encounter MEX5 incorporates non-destructive dual-depth functionality. This is accessed by pressing the  Select button when in NDT non-destructive mode. The regular non-destructive penetration depth is 30mm (1 ¼ inches) when using the Wood scale, Drywall-Roofing scale, Plaster-Tile scale, or Masonry scale. The Shallow Depth scales are designed to have a field penetration of up to 9mm (¾ inch). The Shallow Depth Wood scale gives 0 - 30 %MC for wood, and when used on non-wood materials can be considered similar to comparative 0-30 NDT WME readings (Non-Destructive Test Wood Moisture Equivalent). The Drywall and Plaster-Tile scales also have their own Shallow Depth scales for comparative 0-99 REL readings. The Masonry scale does not have a shallow depth scale. While the Shallow Depth scale eliminates the influence of any substrate beyond 9mm (¾ inch), the regular depth does not eliminate the surface coating.

**In Pin Probe mode** the Moisture Encounter MEX5 is a resistance-type pin-meter that works on the principle of DC resistance. When the electrode pins are pressed or driven into the wood or other building materials, the electrical resistance between the electrodes is measured. If the material is dry, the resistance is high. If moisture is present in the wood the electrical resistance between the pins changes. The higher the moisture content the greater the reduction in resistance. The level of resistance is accurately measured by the instrument, which translates it into a moisture value. This is a percentage of dry weight moisture content for **Wood**. The MEX5 gives moisture readings from 6% to approx 50%. It should be noted that readings above 27% (nominal value of the fiber saturation point) are indicative only. Pre-programmed wood species can be selected. **OSB** and **Plywood** %MC measurements are also between 6% and 50%.

Pin Probe mode can also be used for **Drywall %MC**. The MEX5 gives Drywall %MC measurements between 0 - 8.5%; Gypcrete %MC measurements between 0 - 6%; and WME readings on a relative scale of 0 -99.9.

### **Note - Pin Probe Mode & Non-Destructive Mode for Wood**

The two main types of moisture meter for measuring moisture content in wood are the pin probe type meter and the non-destructive or impedance type meter. Both types are calibrated based on gravimetric or oven-drying test methods.

The Tramex MEX5 combines both of these methods in one instrument so it is important to understand how each test method works as the results from the two tests may sometimes be different and appear to be contradictory.

The pin probe measures the resistance between two pins, which are inserted into the timber.

The impedance or non-destructive type meter has two electrodes, which transmit a low frequency signal into the timber up to a maximum depth of 1¼" (30mm). This meter takes an average reading over a much larger area but the SG specific gravity of the wood being tested has a significant effect on the reading.

When using the MEX5 non-destructive scale or shallow-depth scale, it is possible to adjust the SG specific gravity for better species-dependent readings. Turn on/off the SG adjustment in "Settings - Advanced Features."

If the SG of the material is not known and not listed on pages [21](#) of SG values for popular wood species, it is possible to use the readings from the pin meter to give an approximation of the SG for the non-destructive meter. This is done by adjusting the SG on the non-destructive test until both pin and non-destructive tests give approximately the same reading. This is not as accurate as knowing the exact SG of the material but can be a good indication.

**In Psychrometrics mode** the MEX5 uses its built-in Hygrometer and Infrared Surface Thermometer for psychrometric calculations. The Hygrometer measures Ambient Relative Humidity, Temperature, Dew Point and Humidity Ratio of the environment. The Infrared Surface Thermometer on the base of the meter measures the temperature of the surface. From these measurements the DELTA T Temperature value (difference between the ambient temperature and the dew point temperature) can be displayed.









In Thermal Hygrometer mode, the Enthalpy (heat content levels in the air) can also be viewed alongside the ambient condition values of RH, temperature, dew point and humidity ratio.

**In In-Situ Equilibrium Relative Humidity mode** the Moisture Encounter MEX5 determines the capacitance of the RH probe sensor (built-in or optional plug-in) which varies with the relative humidity of the in-situ testing environment. The Moisture Encounter MEX5 displays this capacitance as a percentage relative humidity. It also measures temperature and displays dew point and humidity ratio.

## OPERATING INSTRUCTIONS - Overview











The instrument face with brief notes on the push button controls and LCD is shown below.





1. Ambient RH Probe
2. Digital display
3.  Menu button
4.  Hold button
5.  Bluetooth ON/OFF
6. Bayonet connection for Wood Probe
7.  Light button
8.  SCROLL UP button
9.  SELECT button
10.  ON/OFF button
11.  SCROLL DOWN button



## Quick Start Operating Instructions

- Press  to power ON/OFF.
- **Menu:** Press  to access the Menu,  and  to scroll,  to select.
- **Backlight:** Press the  key to turn the backlight on/off.
- **Bluetooth** connectivity to the Tramex Meters App is established automatically once the meter and App are both on.
- **Modes** are selected in the Menu - choose from the Non Destructive mode, the Pin mode (Building Materials, Wood Species, WME), the Psychrometrics/Hygrometer features, the Advanced Features and the Settings such as C°/F° preference and Language.
- **Audio Buzzer** signal will sound when the meter indicates high NDT reading of above 18 %MC in Wood and Shallow Depth mode. In REL mode the audio signal gets progressively faster through medium to higher readings. To turn the audio signal on/off, press the  menu button, scroll  to 'Settings' and press the  select button to turn the buzzer on/off. Press the  menu button to return to the home screen.
- **Low/Medium/High** LEDs help indicate low, medium and high moisture values.
- **Hold**  freezes reading to facilitate ease of recording readings. When the Moisture Encounter MEX5 is in HOLD mode, 'H' is visible on the top left of the display. If HOLD was selected prior to the Moisture Encounter X5 automatically powering off, the frozen display reading is digitally memorized and restored next time ON is selected.
- **Auto power-off** will activate after five minutes if no button is pressed or if no change in meter reading is detected. If a button is pressed or the meter reading changes, the power-off will be extended for a further five minutes.
- **Low Battery** icon will be shown on the display when the battery requires replacement.

## Non-destructive Testing Mode - Operating Instructions

**Non-Destructive Scale Choice:** To choose between scales in Non-Destructive Testing (NDT), press  scroll and press  to select between the Wood, Drywall-Roofing, Plaster-Tile, and Masonry scales.

**Shallow Depth scales:** Once you have chosen your NDT scale, the Shallow Depth scales are accessed by pressing the  Select button. In the Shallow Depth Wood scale the reading measurements are in percentage moisture content (%MC) for measuring wood moisture content. When testing non-wood materials, the readings can be considered as comparative NDT WME readings (Non Destructive Test Wood Moisture Equivalent). The Drywall and Plaster-Tile scales also have their own Shallow Depth scales for comparative 0-99 REL readings. The Masonry scale does not have a shallow depth scale.

**Method:** Hold your Moisture Encounter MEX5 directly on the material being tested ensuring the electrodes on the base are fully in contact with the surface. The meter should be held by the rubber grips when taking readings. It is advised to not slide the meter across the surface under test. Place the meter on the surface, record the reading, lift and repeat. For users who do slide the meter, Slide Protectors are available online at [tramexmeters.com](http://tramexmeters.com) (Product Code: MESP)





**Wood %MC scale:** In the Wood scale the reading measurements are in percentage moisture content (%MC).

**Comparative/relative, REL scales:** The Drywall-Roofing, Plaster-Tile and Masonry scales provide comparative readings from 0 to 99. The Low/Med/High LEDs help indicate low, medium and high moisture values. The readings on these scales are not to be interpreted as a measurement of percentage moisture content (MC%) or relative humidity (RH). It is not a relative humidity reading and it does not have any linear correlation with Relative Humidity measurements. These scales should be regarded as a comparative or qualitative scale only.



### LED Low/Med/High indicator:





- The LED indicator breaks down as follows for Wood and Shallow Depth Wood scales:  
Green 0 -13.9% / Yellow 14 - 17.9% / Red 18 - 30 %.  
These are generally accepted as a good indicator of low, medium and high %MC values in wood.
- For the comparative REL scales, the breakdown is:  
Green 0 - 35 / Yellow 36 - 51 / Red 52 -99

## Non Destructive Mode - Advanced Features

To access the Advanced Features, press  to access the Menu,  and  to scroll and  to select Settings. In Settings press  to select Advanced Features. Within Advanced Features choose from the following options relevant to the non-destructive testing modes.

- **'Baseline' Reference reading**

When in the Advanced Features menu, use the  select button to turn Baseline Ref on/off, and press the  menu button to return to the home screen.

To set the baseline, press the meter onto the material under test to obtain a reading. Press the  Pause button and then the  Select button. The meter will show the baseline selected. To change the base line, repeat the process: Press the  Pause button and then the  Select button.

The Baseline Ref feature can only be used with all Non-Destructive scales.





The 'Baseline' Reference reading can be used as a 'known dry reading' or 'drying goal reading'. When placing the MEX5 on a known dry area, that reading can be recorded to be the baseline reading, and readings in other areas will be compared to that baseline reading.

If the Baseline Ref is 10, and the reading is 12, the meter will show +2 under the 10 baseline.

If the Baseline Ref is 10, and the reading is 8, the meter will show -2 under the 10 baseline.

With a Baseline Ref selected, the yellow light will stay on. When readings are taken that are less than the baseline, the green light will also come on. When readings are taken that are more than the baseline, the red light will also come on.

- **Specific Gravity of Wood adjustment**

This allows for adjustment of the sensitivity of the meter readings to correlate to the density of the wood under test according to that wood's SG value. When in the Advanced Features menu, use the  select button to turn NDT SG Adjust on/off, and press the  menu button to return to the Wood-Timber or Shallow Depth scales home screen. The SG will be indicated on the top right of the home screen and can be adjusted using the  and  buttons.



The range of SG covered is 0.30 to 0.80. The SG increases and decreases in increments of 0.01.

A chart showing the approximate specific gravity of a range of different species is shown on page [21](#). For SG greater than 0.80, set the SG at 0.50 (or turn the SG Adjust to off) and refer to [species adjustment table](#) at the end of this user guide.

Only when the NDT SG Adjust is ON will the adjustment indicator appear on the NDT Wood-Timber or Shallow Depth scales home screen.

When the NDT SG Adjust is OFF, the default SG calibration value used is 0.5SG.





- **Surface Temperature**



When in the Advanced Features menu, use the  select button to turn NDT Surface Temp on/off, and press the  menu button to return to the home screen. The surface temperature is taken from the infrared thermometer on base of the meter and will be indicated by Ts on the top left of the home screen.



## Pin Probe Mode - Operating Instructions

This mode is activated automatically by plugging one of the optional Pin Electrodes into the socket at the top of the instrument.

For selections with Pin Probe mode, scroll the Pin Probe menu. The last selected Pin Probe options will be the default selection.

**Pin Probe Scale Choice:** To choose between scales in Pin Probe mode, press , scroll and press  to select Pin Probe. Once in the Pin Probe menu, press  and  to scroll between the Building Materials, Wood Species, WME and Calibration Check options.

**Building Materials:** Select your building material by pressing  and  to scroll and  to select between Wood, Drywall, OSB, Plywood or Gypcrete.

**Wood Species:** Select your preferred pre-programmed Wood Species by pressing  and  to scroll and  to select between the 20 options. The readings are in % Moisture Content values on a scale of approximately 6.5% to approximately 50%MC. An additional 500+ wood species are available through the Tramex Meters App.

**Wood LED Low/Med/High indicator:** The LED indicator breaks down as follows for Wood: Green 0 -13.9% / Yellow 14 - 17.9% / Red 18 - 50 %. These are generally accepted as a good indicator of low, medium and high %MC values in wood.

**Drywall:** The Pin Probe allows for %MC Moisture Content measurements in drywall on a scale of 0-8.5%. **Drywall LED Low/Med/High indicator:** The LED indicator breaks down as follows for Drywall: 0 - 0.5 / 0.6 - 0.7 / 0.8 - 8.5 %. These are generally accepted as a good indicator of low, medium and high %MC values in drywall.

**OSB and Plywood:** The readings are in % Moisture Content values on a scale of approximately 6.5% to approximately 50%MC. **OSB and Plywood LED Low/Med/High indicator:** The LED indicator breaks down as follows for OSB and Plywood: Green 0 -12.9% / Yellow 13 - 19.9% / Red 20 - 50 %. These are generally accepted as a good indicator of low, medium and high %MC values in OSB and Plywood.





**Gypcrete:** The Pin Probe allows for %MC Moisture Content measurements in drywall on a scale of 0-6%. **Gypcrete LED Low/Med/High indicator:** The LED indicator breaks down as follows for Gypcrete: 0 - 0.5 / 0.6 - 0.7 / 0.8 - 6 %. These are generally accepted as a good indicator of low, medium and high %MC values in gypcrete.

**WME:** WME Wood Moisture Equivalent readings are used in non-wood materials as a standard comparative scale, based on an equivalent reading in wood. The readings are not percentages. The WME scale ranges from 0-99. **WME LED Low/Med/High indicator:** The LED indicator breaks down as follows for WME: Green 0 -13.9 / Yellow 14 - 17.9 / Red 18 - 99.

**Calibration Check:** The built-in automatic three-point calibration values are compared with reference resistances traceable to standard oven drying tests, providing a reliable calibration check across the range of different wood standards.





## Pin Probe Mode - Advanced Features

To access the Advanced Features, press  to access the Menu,  and  to scroll and  to select Settings. In Settings press  to select Advanced Features. Within Advanced Features choose from the following options relevant to the Pin Probe testing modes.

- **Pin Temperature Correction:** The Pin Temperature Correction option allows for the meter to make the corrections to the %MC readings depending on the temperature of the wood using the built-in surface thermometer on the base of the meter. When in the Advanced Features menu, use the  select button to turn Pin Temp Correction on/off, and press the  menu button to return to the home screen. In Pin Probe mode, press the  select button to set the Tset temperature.
- **Pin EMC:** The EMC Expected Moisture Content option allows the meter to give an expected moisture content value based on the ambient temperature and relative humidity conditions. When in the Advanced Features menu, use the  select button to turn Pin EMC on/off, and press the  menu button to return to the home screen.

## Psychrometrics Mode - Operating Instructions

When the MEX5 is on, the screen permanently displays the ambient conditions readings of temperature, relative humidity, dewpoint and humidity ratio from the built-in Hygrometer on the top of the meter.

Other Psychrometric features can be found in the Psychrometric Mode. Press the  Menu button, scroll  and  to 'Psychrometrics', press  to select, and scroll and select from the following options:

### Delta Temperature:

The Delta T is the difference between the surface temperature of a material and the dewpoint temperature (temperature at which condensation is likely to form).

Once selected, the MEX5 screen will show the Delta T in the center of the screen, with the ambient conditions listed at the foot of the screen, the surface temperature top left, and the Emissivity value top right of the screen.

The Emissivity can be adjusted up or down by using the  and  scroll buttons.

### Surface Temperature:

Once selected, the MEX5 screen will show the Surface Temperature in the center of the screen, with the ambient conditions listed at the foot of the screen and adjustable Emissivity value top right of the screen.

The Emissivity can be adjusted up or down by using the  and  scroll buttons.

### Thermal Hygrometer:

Once selected, the MEX5 screen will show the ambient conditions readings of temperature, relative humidity, dewpoint, humidity ratio, surface temperature and enthalpy (heat content in the air) values in full screen.

## In-Situ Equilibrium Relative Humidity Mode - Operating Instructions

To operate the In-situ Equilibrium Relative Humidity Probe mode, simply connect the TrameX external RH probe of your choice. The MEX5 will automatically switch to this mode and display the external in-situ RH probe readings of temperature, RH, dew point temperature and humidity ratio on the full screen, with the ambient readings from the meter's built-in hygrometer along the bottom of the screen.



The external in-situ RH probe sensors utilize state of the art electronic technology to provide an easy to use and accurate method for measuring in-situ equilibrium temperature, relative humidity, dew point and humidity ratio in a wide range of applications such as:





- Heating, ventilation and air conditioning (HVAC) systems.
- Environmental and building monitoring.
- Building inspection.
- Concrete flooring (including in-situ method as per and hood methods as per International Standards: ASTM F2170 & BS 8201, 8203, 5325)

## Settings - Operating Instructions

### Advanced Features:

- **'Baseline' Reference reading**

When in the Advanced Features menu, use the  select button to turn Baseline Ref on/off, and press the  menu button to return to the home screen.





To set the baseline, press the meter onto the material under test to obtain a reading. Press the  Pause button and then the  Select button. The meter will show the baseline selected. To change the base line, repeat the process: Press the  Pause button and then the  Select button. The Baseline Ref feature can only be used with all Non-Destructive scales.

The 'Baseline' Reference reading can be used as a 'known dry reading' or 'drying goal reading'. When placing the MEX5 on a known dry area, that reading can be recorded to be the baseline reading, and readings in other areas will be compared to that baseline reading.

If the Baseline Ref is 10, and the reading is 12, the meter will show +2 under the 10 baseline. If the Baseline Ref is 10, and the reading is 8, the meter will show -2 under the 10 baseline. With a Baseline Ref selected, the yellow light will stay on. When readings are taken that are less than the baseline, the green light will also come on. When readings are taken that are more than the baseline, the red light will also come on.

- **Specific Gravity of Wood adjustment**

This allows for adjustment of the sensitivity of the meter readings to correlate to the density of the wood under test according to that wood's SG value.



When in the Advanced Features menu, use the  select button to turn NDT SG Adjust on/off, and press the  menu button to return to the Wood or Shallow Depth scales home screen. The SG will be indicated on the top right of the home screen and can be adjusted using the  and  buttons.

The range of SG covered is 0.30 to 0.80. The SG increases and decreases in increments of 0.01. A chart showing the approximate specific gravity of a range of different species is shown on page [21](#). For SG greater than 0.80, set the SG at 0.50 (or turn the SG Adjust to off) and refer to the [species adjustment table](#) at the end of this user guide.



Only when the NDT SG Adjust is ON will the adjustment indicator appear on the NDT Wood-Timber or Shallow Depth scales home screen.

When the NDT SG Adjust is OFF, the default SG calibration value used is 0.5SG



- **Surface Temperature**

When in the Advanced Features menu, use the  select button to turn NDT Surface Temp on/off, and press the  menu button to return to the home screen. The surface temperature is taken from the base of the meter and will be indicated by Ts on the top left of the home screen.





- **Pin probe temperature correction**

The Pin Temperature Correction option allows for the meter to make the corrections to the %MC readings depending on the temperature of the wood. When in the Advanced Features menu, use the  select button to turn Pin Temp Correction on/off, and press the  menu button to return to the home screen. In Pin Probe mode, press the  select button to set the Tset temperature.





- **Pin probe EMC of Wood (Expected Moisture Content)**

The EMC Expected Moisture Content option allows the meter to give an expected moisture content value based on the ambient conditions. When in the Advanced Features menu, use the  select button to turn Pin EMC on/off, and press the  menu button to return to the home screen.

- **Buzzer**

The High Reading Audio signal will sound when the meter indicates high NDT reading of above 18 %MC in Wood and Shallow Depth mode. In REL mode the audio signal gets progressively faster through medium to higher readings. To turn the audio signal on/off, press the  menu button, scroll  to 'Settings' and press the  select button to turn the buzzer on/off. Press the  menu button to return to the home screen.





- **C°/F° Celsius/Fahrenheit choice**

To choose between Celsius and Fahrenheit preferences, press the  menu button, scroll  to 'Settings' and press the  select button to choose. Press the  menu button to return to the home screen. Choosing Celsius will also change the Humidity Ratio to g/kg and Enthalpy to kJ/kg. Choosing Fahrenheit will also change the Humidity Ratio to GPP and Enthalpy to Btu/lb.

- **Backlight Timeout**

To turn the Backlight Timeout on/off, press the  menu button, scroll  to 'Settings' and press the  select button to choose. Press the  menu button to return to the home screen.

- **Language**

To choose your language preference, press the  menu button, scroll  to 'Settings' and press the  select button to choose. Press the  menu button to return to the home screen.



## NON-DESTRUCTIVE TESTING MEASUREMENT MODE GUIDE

### **Note - Scale Choice, Material density and Scale Sensitivity:**

It is important that the appropriate scale is used for the type of material being tested. This ensures that the most accurate and meaningful readings are obtained. The scale descriptions on the instrument show the materials that the meter scales were optimized for. The Wood-Timber and Shallow Depth Wood scales are calibrated to measure wood moisture content %MC. The comparative REL scales can be used on the materials named, but also on other materials. Choose the scale that is most appropriate to the density of the material under test. i.e. the least sensitive 'Masonry' scale can be used for the more dense materials. The most sensitive 'Drywall-Roofing' scale can be used for less dense materials.

### **Note - Depth of Non-Destructive Penetration:**

The depth of the non-destructive penetration field of each scale depends on the density of the material being tested. These fields penetrate the material under test to approximately 30mm (1 1/4 inches) from the surface. When testing thin materials such as wood veneers it is recommended that they are stacked to at least that thickness.

### **Note - Depth of Penetration field - Shallow Depth Scale:**

The shallow depth scales' field depth of penetration is reduced to approximately 9mm (3/8 inch) also depending on the density of the material.

Use Shallow Depth Wood scale for %MC measurements in wood to a depth of up to 9mm (3/8 inch) In non-wood materials, the Shallow Depth Wood scale can be used for comparative readings, and should not be considered %MC values, but can be considered as NDT WME readings (Non-Destructive Test Wood Moisture Equivalent readings). The Drywall and Plaster-Tile scales also have their own Shallow Depth scales for comparative 0-100 REL readings. The Masonry scale does not have a shallow depth scale.

### **Note: Slide Protectors**

It is advised to not slide the meter across the surface under test. Place the meter on the surface, record the reading, lift and repeat. Slide Protectors are available to protect the electrodes online at [tramexmeters.com](http://tramexmeters.com) (Product Code: MESP).

The Moisture Encounter MEX5 enables dual-depth, non-invasive moisture measurement of % Moisture Content in wood, and comparative (REL) readings in wood by-products and a wide range of building materials including drywall, roofing, plaster, tiles and masonry.

## WOOD SCALE GUIDE

### Introduction

- a. When testing wood flooring & wood products, select the Wood Scale and lightly press the rubber electrodes directly to the surface.
- b. If possible, always take readings with the length of the instrument parallel to the direction of the wood grain.
- c. Avoid taking readings on wood from the top of a stack stored outside as these may be affected by surface moisture from recent rain.
- d. The LED Low/Med/High indicator breaks down as follows: Green 0 -13.9% / Yellow 14 - 17.9% / Red 18 - 30 %. These are generally accepted as a good indicator of low, medium and high %MC values in wood.
- e. If readings are in the high range (red LED) and if the audio is turned on, it will sound when readings go above 18%.
- f. For operation instructions of the NDT Wood scale, see [page 10](#)

### Using the Wood Scale

- a. As a rule of thumb and depending on the climatic conditions:
  - Exterior wood is generally considered safe for painting when the moisture content is 14% or below.
  - Wood below 10% is generally considered suitable for painting indoors. (Always check coating manufacturers recommendations).
- b. The following moisture content levels are used in the wood industry but as a guide only. Contact industry associations and manufacturers for their specifications.
  - Furniture: 5% to 6% in areas of low relative humidity and up to 10% to 11% may be acceptable where the relative humidity is higher.
  - Indoors wood: 6% in low humidity areas. Up to 12% in higher humidity locations.
  - Exterior wood: 10% to 15% depending on local humidity levels.
  - Generally, wood moisture content in excess of 23% - 25% is susceptible to rot.
  - Wood moisture content in excess of 18% - 20% may provide an environment for termite and wood boring insects to thrive and multiply. Wood at these high levels can also support mold and biological growth.
  - Wood at 28% moisture content is considered to have reached fiber saturation point.
- c. Avoid taking readings on wood from the top of a stack stored outside as these may be affected by surface moisture from recent rainfall.
- d. When measuring in chemically treated wood, consider the effects chemical treatment may have on readings. It may not be possible to consider the readings as quantitative measurements, but as qualitative comparisons. A known dry sample can be used as the comparative reading to refer to.
- e. It is advised to not slide the meter across the surface under test. Place the meter on the surface, record the reading, lift and repeat. Slide protectors are available online at [tramexmeters.com](http://tramexmeters.com)

**Note: Adhesives**

The presence of different species, treatments, adhesives, etc., within products such as plywood, particleboard, OSB (oriented strand board), laminate and engineered woods will affect non-destructive measurements. It may not be possible to consider the readings as quantitative measurements, but as qualitative comparisons. A known dry sample can be used as the comparative reading to refer to.

If in doubt please contact us and, if you wish, we can work with you in developing your own calibration for a specific product.

**Relative Humidity and Moisture Content**

Acceptable levels of moisture content depend on the climate conditions and we advise you check the levels acceptable in your area. The table below shows the approximate relationship between the ambient relative humidity and equilibrium moisture content in wood, and is useful when testing in NDT mode. (These figures are approximate values at a temperature of 70° F, and may vary for different species.)

(When using the optional Pin Probe, the built-in Pin temperature correction feature can be used.)

Relative Humidity	Wood MC %
10 %	3 to 5
20 %	5 to 6
30 %	6 to 8
40 %	8 to 10
50 %	10 to 11
60 %	11 to 13
70 %	13 to 15
80 %	15 to 18
90 %	18 to 23
100 %	23+

### Specific Gravity

If the SG adjustment is not switched ON in 'Settings, Advanced Features', a default SG of 0.50 is used.

The specific gravity (SG) of wood is the ratio of the density of wood to the density of water at a specified temperature (generally 4°C where the density of water is at its maximum). The density of wood is usually based on the oven-dry weight and the volume at the specified moisture content (MC%), generally 12%.

### Specific Gravity Adjustment Table (SG > 0.80)

The following table shows how the SG can affect MC readings.

Reading S.G. set at 0.5	SG			
	0.85	0.9	0.95	1
	Adjustment			
5 to 9	-3	-4	-4	-4
10 to 12	-4	-5	-5	-5
13 to 15	-5	-6	-6	-6
16 to 18	-6	-7	-7	-8
19 to 21	-7	-8	-9	-10
22 to 24	-9	-9	-11	-11
25 to 27	-11	-11	-12	-13
28 to 30	-12	-13	-13	-14
31 to 33	-14	-14	-14	-15
34 to 36	-15	-15	-15	-16

## Table of Wood Specific Gravities (SG)

### HARDWOODS ( Am. = American )

Alder, Red (Am. Alder, Western Alder) <i>Alnus rubra</i> .....	0.41
Ash, White (Northern/Southern Ash) <i>F. americana</i> .....	0.60
Aspen, Quaking (Am. Aspen) <i>Populus tremuloides</i> .....	0.38
Basswood (Am. Basswood, Linden) <i>Tilia americana</i> .....	0.37
Beech <i>Fagus Grandifolia</i> .....	0.64
Birch, Yellow (Gray, Silver, Swamp) <i>B. alleghaniensis</i> .....	0.62
Cherry (Am. Black Cherry) <i>Prunus serotina</i> .....	0.50
Cottonwood (Eastern Cottonwood) <i>Populus deltoides</i> .....	0.40
Elm, Red (Slippery elm) <i>Ulmus rubra</i> .....	0.53
Hackberry (Common Hackberry) <i>Celtic occidentalis</i> .....	0.53
Hickory (Pignut, True Hickory) <i>Carya glabra</i> .....	0.75
Maple, Am. Hard (Sugar Maple) <i>Acer saccharum</i> .....	0.63
Maple Am. Soft (Red Maple) <i>Acer rubrum</i> .....	0.54
Maple, Silver <i>Acer saccharinum</i> .....	0.47
Maple, Black <i>Acer nigrum</i> .....	0.57
Oak, Northern Red <i>Quercus rubra</i> .....	0.63
Oak, Southern Red (Cherrybark) <i>Quercus falcata</i> .....	0.68
Oak, White (Am. White Oak) <i>Quercus alba</i> .....	0.68
Pecan Hickory (Am. Pecan) <i>Carya illinoensis</i> .....	0.66
Red Gum (Sweetgum) <i>Liquidambar styraciflua</i> .....	0.52
Sassafras (Golden Elm) <i>Sassafras albidum</i> .....	0.46
Sycamore (Am. Planetree, Buttonwood) <i>P. occidentalis</i> .....	0.49
Walnut, Black (Am. Walnut) <i>Juglans nigra</i> .....	0.55
Willow, black (Am. Willow) <i>Salix nigra</i> .....	0.39
Yellow Poplar (Am. Tulipwood, Tulip Poplar, Canarywood) <i>Liriodendron tulipifera</i> .....	0.42

### SOFTWOODS

Cedar, Alaska (Alaskan Yellow).....	0.44
Cedar, Incense.....	0.37
Cedar, Port-Orford.....	0.43
Cedar, Western Red.....	0.32
Douglas Fir, Coast.....	0.48
Douglas Fir, Interior West.....	0.50
Fir, California Red.....	0.38
Fir, Grand.....	0.37
Fir, Noble.....	0.39
Fir, Pacific Silver.....	0.43
Fir, White.....	0.39
Hemlock, Western.....	0.45
Larch, Western.....	0.52
Pine, Lodgepole.....	0.41
Pine, Ponderosa.....	0.40
Pine, Sugar.....	0.36
Pine, Western White (Idaho).....	0.38
Spruce, Englemann.....	0.35
Spruce, Sitka.....	0.40

### EXOTIC

Balsa.....	0.16
Ebony.....	1.10
Karri.....	0.82
Padauk.....	0.77
Tulipwood.....	0.96

## SHALLOW-DEPTH SCALE GUIDE

The Shallow Depth Wood scale will read to a depth of up to 9mm ( $\frac{3}{8}$  inch) in the materials under test, giving % moisture content measurements for wood and comparative readings in non-wood materials. These comparative readings can be considered similar to NDT WME readings (Non-Destructive Test Wood Moisture Equivalent). The Drywall and Plaster-Tile scales also have their own Shallow Depth scales for comparative 0-99 REL readings. The Masonry scale does not have a shallow depth scale.

The depth of the field of penetration in Shallow depth mode will depend on the density of the material being tested.

The Shallow Depth scale allows for:

- the reduction or elimination of substrate influence when testing the moisture conditions of floor or wall coverings on a substrate. Shallow depth reads the surface and top 9mm ( $\frac{3}{8}$  inch) only.
- greater accuracy and precision of the readings.
- shallow depth wood %MC measurements with optional SG specific gravity adjustment.
- comparative readings at a shallow depth in non-wood materials similar to NDT WME Wood Moisture Equivalent readings , or 0-99 REL.

### NOTE:

While the Shallow Depth scale eliminates the influence of the substrate beyond 9mm ( $\frac{3}{8}$  inch), the regular depth does not eliminate the surface coating. The regular depth Scales of Drywall-Roofing, Plaster-Tile and Masonry give readings from the surface to a depth of up to 30mm (1  $\frac{1}{4}$  inches). These regular depth scales and their shallow depth versions are comparative, REL scales of 0 - 99. The shallow depth wood scale of 0-30 MC, when used on these non-wood materials, can be considered as 0-30 WME Wood Moisture Equivalent.

### Using the Wood scale alongside the Shallow-Depth scale for Wood

The Shallow Depth scale is calibrated to work in conjunction with the Wood Scale. When using both shallow and regular wood scale the user can get a comparative of %MC moisture conditions up to a depth of 9mm ( $\frac{3}{8}$  inch) and moisture conditions up to a depth of 30mm (1  $\frac{1}{4}$  inches) within wood. Shallow depth scale used on wood will give a %MC with an adjustable SG value, as does the Wood scale. While the Shallow Depth scale eliminates the influence of any substrate beyond 9mm ( $\frac{3}{8}$  inch), the regular depth will read both the surface covering and beyond to a depth of 30mm. This dual-depth feature gives the user more versatility and allows for a better understanding of moisture conditions at different depths.

### Flooring with Wood & Shallow-Depth Scale

Excess moisture in wood flooring or concrete sub-floors can cause major problems.

- a. If installed with excess moisture, the wood can subsequently shrink leading to job failure.
- b. If a wood floor (solid, laminated or engineered) is installed above wet concrete the wood can absorb moisture emitting from the concrete causing the wood to swell and buckle and even cause structural damage to the building.
- c. When vinyl or other impervious coverings are applied over wet concrete, the result can be failure of the adhesive and blistering of the surface.

Prior to installation, the Moisture Encounter MEX5 can be used to measure the moisture content of the wood flooring materials to ensure they meet specification. As the meter will read up to 30mm (1 1/4 inches) it is advisable to stack the wood to at least that depth when using the Wood scale.

Post-installation, the Moisture Encounter MEX5 can be used to check, on a qualitative basis, within and beyond the floor covering, and identify elevated moisture in the substrate. The Wood scale will read both within the wood floor covering and beyond into the substrate allowing for comparative readings with a known dry area. When using the Shallow Depth Wood Scale, in this situation, the Moisture Encounter MEX5 will read up to a depth of 9mm (3/8 inch), thus reducing the influence of the substrate.

Shallow Depth Wood readings on hardwood flooring are % moisture content measurements. For engineered wood flooring and other non-wood floor coverings, shallow depth readings should be considered as comparative WME Wood Moisture Equivalent readings.

**Note:** You can use the other regular or shallow depth scales in the Moisture Encounter MEX5 on engineered wood flooring and other non-wood floor coverings if there are density issues and you need less/more sensitivity to get meaningful comparative readings.

### CARPET, VINYL & LOW DENSITY FLOOR COVERINGS (COMPARATIVE)

When inspecting installed floor covering for moisture related failures the Moisture Encounter MEX5 can be used to look within and beneath the floor covering. Testing will be done on a comparative basis. The Moisture Encounter MEX5 has scales of varying sensitivity and the scale to use will be determined by the density of the materials (both the floor covering and the substrate). It is advisable to use one of the shallow depth scales as this is best for taking readings in and just beneath the floor covering.

Firstly, find a 'known dry area' and choose the meter scale that gives a reading closest to zero on the dry area, but not zero, on the 0-99 REL scale, or closest to 0, but not 0, on the 0-30 %MC scale. This indicates that the meter is detecting and also has the range to detect higher moisture levels in other areas. Then, use the meter across the area under test on a comparative basis to locate higher moisture readings, compared to the known dry area baseline reading.

These are comparative readings and not quantitative measurements.

To get quantitative measurements of a concrete substrate it is necessary to remove the floor covering to get direct access to the clean bare concrete and utilize a Concrete Moisture Encounter to obtain a %MC measurement.

## DRYWALL-ROOFING SCALE GUIDE

The Drywall-Roofing scale is a comparative (relative) scale that has a high sensitivity and deep non-destructive penetrating field.

### Drywall

The Moisture Encounter MEX5 can identify excess moisture within and behind drywall. As NDT calibration is not practical on this type of construction, readings are comparative or relative (REL).

The Shallow Depth scale can be utilized for Drywall if readings are required whilst reducing the influence of the substrate materials. To access the Shallow Depth Drywall scale from the regular depth Drywall-Roofing scale press the  select button.

Excess moisture trapped behind covering materials can cause major problems and, if undetected, can eventually lead to system failure. As calibration is not practical on all types of construction materials, readings are comparative.

**Note:** You can use other scales if there are density issues and need less/more sensitivity. Should the scale prove to be too sensitive for testing ceramic tiles or other coverings, reduce sensitivity by choosing a less sensitive scale, such as Plaster-Tile or its shallow depth scale.



## Roofing

This scale allows the user to detect the presence of moisture in built-up roofing systems covered with multi-ply roofing felt, PVC, modified bitumen (torchon) or other non-conductive membranes. As calibration is not practical on this type of construction, readings are comparative.

- a. The presence of moisture in built-up roofing systems covered with multi-ply roofing felt, PCV, modified bitumen (torched-on) or other membranes, can cause blistering and splitting of the roof surface, In addition moisture can cause considerable damage to the contents and fabric of the buildings as well as heat loss through wet insulation. Your MEX5 can be used to help confirm a new roof has been installed dry.
- b. When the waterproofing membrane develops a leak, the water can travel within the built-up-roof structure and enter the building some distance away. Testing the membrane surface and comparing the dry areas with areas where moisture is present below the surface can assist in tracing such a leak to its source.
- c. As there are many different types and thickness sizes of roofing membranes, it is not possible to give a calibrated percentage measurement. Instead, the comparative scale, 0 - 99, is used for checking the difference between wet and dry.
- d. If gravel surfacing is present, this should be removed to ensure your Moisture Encounter X5 MEX5 comes into direct contact with the surface of the membrane.
- e. It is recommended that a core be cut to determine the depth and extent of the moisture before carrying out roof repairs. Alternatively, the area can be checked with the MEX5 and the optional external resistance type pin probe with insulated pins.

## PLASTER-TILE SCALE GUIDE

The Plaster-Tile scale is a comparative (relative) scale that has a medium sensitivity and depth non-destructive penetrating field.

### Plaster

The Plaster-Tile scale has a medium sensitivity and a deep nondestructive penetrating field and can be used to detect the presence of moisture in plastered walls and ceilings. The moisture profile of the surface can be determined by taking readings across the entire surface. Place and press the meter lightly on the surface, record and repeat. As calibration is not practical on this type of construction, readings are comparative (REL 0-99).

The Shallow Depth Plaster-Tile scale can be utilized if readings are required whilst reducing the influence of the substrate materials. To access the Shallow Depth Plaster-Tile scale from the regular depth Plaster-Tile scale press the  select button.

- a. The Moisture Encounter MEX5 will help identify the different levels of moisture, even if not apparent on the surface. Moisture can often be trapped behind the wall coverings.
- b. Rising damp and moisture migration from leaks and defective, or non-existent, vapor barriers can be identified and profiled and often its source identified.
- c. Water damage following flooding or firefighting can be checked and drying out and the dehumidification process can be monitored.

**Note - Acceptably Dry Plaster:** The Moisture Encounter MEX5 will give low readings when the plaster is acceptably dry. Due to the hygroscopic nature of this material, moisture values are affected by ambient humidity and thus can vary according to the climate conditions. We recommend checking what is 'acceptably dry' in your area and use the instrument to compare these with readings that are 'acceptable' or 'unacceptable'.

### Tile

Due to the medium sensitivity and depth of this non-destructive penetrating field, this scale can be used to detect the presence of moisture both within and behind the ceramic or porcelain tile and within the substrate material. As calibration is not practical on this type of construction, readings are comparative.

The Shallow Depth Plaster-Tile scale can be utilized if readings are required whilst reducing the influence of the substrate materials. To access the Shallow Depth Plaster-Tile scale from the regular depth Plaster-Tile scale press the  select button.

The Moisture Encounter MEX5 Tile scale can be used to detect elevated moisture conditions within and behind most types of tile including ceramic and porcelain. Excess moisture trapped behind covering materials such as tiles can cause major problems like decay, delamination and mold growth. The longer these problems go undetected, the worse the problem can get eventually leading to system failure.

## MASONRY SCALE GUIDE

The Masonry scale has low sensitivity and deep non-destructive penetrating field and can be used when detecting the presence of moisture within more dense materials such as brick, block and concrete. As calibration is not practical on this type of construction, readings are comparative.

**IMPORTANT Concrete Moisture Measurement** - The Moisture Encounter MEX5 is not calibrated for concrete. The Tramex Concrete Moisture Encounter CME5 or CMEX5 are specifically designed for concrete flooring and recommended where quantitative measurements are required. However, a useful comparative indication of the moisture conditions of the concrete or subfloor can be obtained with the MEX5 set on the Masonry Scale.

**Note: Acceptably Dry Brick, Block:**

The Moisture Encounter MEX5 will give low readings when the brick, block is acceptably dry. Due to the hygroscopic nature of this material, moisture values are affected by ambient humidity and thus can vary according to the climate conditions. We recommend checking what is 'acceptably dry' in your area and use the instrument to compare these with readings that are 'acceptable' or 'unacceptable'.



## PIN PROBE MODE GUIDE

This mode is automatically activated by plugging one of the optional Pin Electrodes into the bayonet socket at the top of the Moisture Encounter MEX5. In pin probe mode the Moisture Encounter MEX5 works on the principle of electrical resistance. When the electrode pins are pressed or driven into the wood or other material, the electrical resistance between the electrodes is measured and indicated on the digital display. If the wood or material is dry, the resistance is very high. The higher the moisture content, the lower the resistance. This resistance is accurately measured by the instrument, which translates it into percentage moisture content for wood, a WME reading for other materials, and a Drywall %MC reading.

The Moisture Encounter MEX5 gives % moisture content readings for wood from 6.5% to approximately 50%. It should be noted that readings above 25 are indicative only (27% is the nominal value of the fiber saturation point).

## PIN PROBE MENU SELECTIONS

For Pin Probe operating instructions, see page [10](#).

- **Building Materials:** Select your building material by pressing  and  to scroll and  to select between Wood, Drywall, OSB, Plywood or Gypcrete.
- **Wood Species**  
The MEX5 has 20 pre-programmed wood species. There are an additional selection of 500+ in the Tramex Meters App that can be used in conjunction with the MEX5 in Pin Probe mode. Just select the appropriate species in the menu and the MEX5 will do the species adjustment automatically. There is a species correction table available at the end of this user guide for reference if needed.
- **WME**  
The WME scale is a Wood Moisture Equivalent scale for comparative pin readings in many building materials. WME Wood Moisture Equivalent readings are used in non-wood materials as a standard comparative scale, based on an equivalent reading in wood. WME is the theoretical moisture content value that would be attained by a piece of wood in moisture equilibrium with the material under investigation at the point of measurement. The readings are not percentages. The WME scale ranges from 0-99.
- **Calibration Check**  
The built-in automatic three-point calibration values are compared with reference resistances traceable to standard oven drying tests, providing a reliable calibration check across the range of different wood standards.

## FACTORS AFFECTING PIN MOISTURE READINGS IN WOOD

The readings of all moisture meters are influenced by the characteristics of different species of wood as well as temperature and other factors listed below.

### Species

Different species of wood can vary in density and conductivity, which can have an effect on the electrical resistance of the wood. This can influence meter readings for the same moisture content and can also apply to similar species from different origins. A [species correction chart](#) is provided the end of this user guide.

### Temperature

Meter readings can be affected by wood temperature. As pin probe meters are calibrated at certain standard temperature values, high wood temperatures will give falsely high meter readings, and low wood temperature will give meter readings that are falsely low. A temperature correction adjustment is needed. In the MEX5 advanced settings, select the temperature correction ON for the correction to be done automatically by the meter.

### Chemical treatment or contamination

Readings may be affected by certain flame retardants, preservatives, aluminum paint and by contamination by salt water. Treat all readings on such wood as indicative readings only.

### Surface Moisture

Surface moisture due to wetting or condensation can affect readings when uninsulated pins are used. It is recommended that insulated pins such as SP-52 are used in conjunction with a HA-22 Hammer Action electrode. As the pins are driven into the wood, readings can be taken at different depths, unaffected by moisture on the surface.

## PIN MOISTURE READINGS AND WOOD FLOORING

Excess moisture in wood flooring can cause major problems. For instance, if installed with excess moisture, the wood can subsequently shrink leading to job failure. If a wood floor (solid, laminated or engineered) is installed above wet concrete the wood can absorb moisture emitting from the concrete causing the wood to swell and buckle and even cause structural damage to the building.

Your MEX5 in PIN Probe mode can be used to measure the moisture content of the wood floor to ensure it meets specification.



### Testing wood flooring and wood products

- a. If possible, always take readings with the pins parallel to the direction of the wood grain.
- b. Acceptable levels of moisture content depend on climatic conditions and we advise you check the levels acceptable in your area. The Table on [page 31](#) shows the approximate relationship between the ambient relative humidity and equilibrium moisture content in woods.
- c. The following moisture content levels are often quoted in the wood industry and should be used as a guide only. Please contact industry associations and manufacturers for their specifications
  - Furniture: 5% to 6% when used in locations of low relative humidity and up to 10% to 11% may be acceptable where the relative humidity is higher.
  - Interior wood: 6% in low humidity areas. Up to 12% in higher humidity locations.
  - Exterior wood: 10% to 15% depending on local humidity levels.
  - Generally, wood with moisture content in excess of 23% to 25% is susceptible to rot.
  - Wood moisture content in excess of 18% to 20% may provide an environment for termite and wood boring insects to thrive and multiply. Wood at these high levels can also support mold and biological growth.
  - Wood at 28% moisture content is considered to have reached fiber saturation point.
- d. Avoid taking readings on wood from the top of a stack stored outside as these may be affected by surface moisture from recent rain.
- e. When taking measurements in chemically treated wood, it is advisable to allow for possible effects that the treatment may have on readings.

### Note - Concrete and Pin Probes

Pin Probe mode and pins should not be used for concrete or other cementitious materials. A concrete moisture meter such as the Tramex CME5 or CMEX5 are advised.

### PIN TEMPERATURE CORRECTION

The Pin Temperature Correction option allows for the meter to make the correction to the %MC readings when testing at different temperatures. When in the Advanced Features menu, use the select button to turn Pin Temp Correction on/off, and press the  menu button to return to the  home screen. In Pin Probe mode, press the  select button to set the Tset temperature.

## HUMIDITY AND MOISTURE CONTENT RELATIONSHIP





The table below shows the approximate relationship between relative humidity (RH) and equilibrium moisture content (EMC) of some woods. (These figures are approximate values and may vary for different species.)

**Table 1. Approx. relationship between RH and EMC**

Relative Humidity	Wood MC %
10 %	3 to 5
20 %	5 to 6
30 %	6 to 8
40 %	8 to 10
50 %	10 to 11
60 %	11 to 13
70 %	13 to 15
80 %	15 to 18
90 %	18 to 23
100 %	23 +



## PSYCHROMETRICS MODE GUIDE

The Moisture Encounter MEX5 uses its built-in hygrometer to display the ambient relative humidity (RH), ambient temperature (Ta), dew point temperature (Td) and humidity ratio (HR) of the environment permanently along the bottom of the MEX5 display.

**Note:** To choose between Celsius and Fahrenheit preferences, press the  menu button, scroll  to 'Settings' and press the  select button to choose. Press the  menu button to return to the home screen. Choosing Celsius will also change the Humidity Ratio to g/kg and choosing Fahrenheit will also change the Humidity Ratio to GPP.

In Psychrometrics mode in the MEX5 main menu you can also select between the following display screens:

- Delta T temperature display
- Surface temperature display
- Thermal Hygrometer display
- **Delta T Temperature:** The Delta T is the difference between the surface temperature of a material and the dewpoint temperature - the temperature at which condensation is likely to form. This can be particularly useful in the detection of potential for mold growth, where the material surface temperature is close to the dewpoint temperature, and when also considering the ambient conditions and moisture content of the materials.  
On the Delta T display, the Emissivity of the surface can be adjusted between 0.08 and 1.00 according to the material under test. A table of typical emissivity values is provided in the Surface Temperature section below.
- **Surface Temperature:** The surface temperature display shows the temperature of the material under test as measured by the non-contact infrared surface thermometer on the base of the meter. The ambient conditions as measured by the hygrometer are displayed, and emissivity is adjustable between 0.08 and 1.00.

The Baseline feature in the Settings / Advanced Features menu can be used with the Surface Temperature display to compare the surface readings to a selected baseline surface temperature value. To set the baseline, press the meter onto the material under test to obtain a reading. Press the  Pause button and then the  Select button.

**Note on Emissivity:** Emissivity is a term used to describe the energy-emitting characteristics of materials. Most (90% of typical applications) organic materials and painted or oxidized surfaces have an emissivity of 0.95 (pre-set in the unit). Inaccurate readings will result from measuring shiny or polished metal surfaces. To compensate, cover the surface to be measured with masking tape or flat black paint. Allow time for the tape to reach the same temperature as the material underneath it. Measure the temperature of the tape or painted surface.



### Typical Emissivity Values:

Substance	Thermal Emissivity	Substance	Thermal Emissivity
Asphalt	0.90 to 0.98	Cloth (black)	0.98
Concrete	0.94	Human Skin	0.98
Cement	0.96	Lather	0.75 to 0.80
Sand	0.90	Charcoal (powder)	0.96
Earth	0.92 to 0.96	Lacquer	0.80 to 0.95
Water	0.92 to 0.96	Lacquer (matt)	0.97
Ice	0.96 to 0.98	Rubber (black)	0.94
Snow	0.83	Plastic	0.85 to 0.95
Glass	0.90 to 0.95	Timber	0.90
Ceramic	0.90 to 0.94	Paper	0.70 to 0.94
Marble	0.94	Chromium Oxides	0.81
Plaster	0.80 to 0.90	Copper Oxides	0.78
Mortar	0.89 to 0.91	Iron Oxides	0.78 to 0.82
Brick	0.93 to 0.96	Textiles	0.90

- Thermal Hygrometer:** The Moisture Encounter MEX5 uses its built-in hygrometer that measures the ambient relative humidity (RH), ambient temperature ( $T_a$ ), dew point temperature ( $T_d$ ) and humidity ratio (HR) of the environment as well as the surface temperature and Enthalpy.

**Note on Enthalpy:** Enthalpy can be defined as the measurement of energy in a thermodynamic system. The quantity of enthalpy equals the total content of heat of a thermodynamic system.

When air is hot, its enthalpy is high. Enthalpy is also high when air is moist.

Higher enthalpy values will indicate more heat energy in the air, i.e. the more heat is necessary to heat the moisture and evaporate it. When air from outside with a higher enthalpy is mixed with air inside, it requires more energy to cool the mixture back down to the desired temperature. This increased energy consumption results in higher cooling costs. Lower enthalpy values will mean less heat energy and therefore require less energy to cool the air in the thermodynamic system.

## IN-SITU EQUILIBRIUM RELATIVE HUMIDITY PROBE GUIDE

A range of Tramex external relative humidity probes can be used with the MEX5.

Tramex RH Probe sensors utilize state of the art electronic technology to provide an easy to use and accurate method for measuring relative humidity, humidity ratio, temperature and dew point in a wide range of applications such as:

- Heating, ventilation and air conditioning (HVAC) systems.
- Environmental and building monitoring.
- Building inspection.
- Flooring (including in-situ method as per and hood methods as per International Standards: ASTM F2170 & BS 8201, 8203, 5325)

A typical Moisture Encounter MEX5 display with the external RH Probe is shown below.

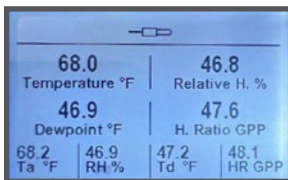

### Building Envelope In-Situ Equilibrium Relative Humidity

Tramex relative humidity probes can be attached to the MEX5 through the bayonet connection at the top of the meter. These resilient and re-usable RH probes allow the user to evaluate moisture conditions within the building structure. The different lengths and thicknesses of the Tramex in-situ RH probes make them ideal for use by Flood and Water Damage Restoration as well as Building Survey professionals. They are ideal for taking relative humidity, temperature and dewpoint readings in small or narrow crevices, in between tiles, and for the evaluation of moisture conditions of wall and cavity structures within the building envelope.

The in-situ probe readings will be shown on the display screen, with the ambient condition readings from the MEX5 hygrometer simultaneously shown on the foot of the display.

### Concrete in-Situ Equilibrium Relative Humidity

There are two International Standard methods of relative humidity measurement in flooring that can be carried out with the Moisture Encounter MEX5 with the external Hygro-i2 probe attached:

(a) In-Situ (below the surface of the slab) ASTM F2170 & BS 8201, 8203, 5325.

(b) RH Hood (on the surface of the floor slab) BS 8201, 8203, 5325.

It is advised to also use a Tramex Concrete Moisture Encounter CME5 or CMEX5 for non-destructive testing.

### a) In-Situ Equilibrium Relative Humidity Test Method – Guidelines.

Perform 3 per 100m<sup>2</sup> (1000ft<sup>2</sup>) and 1 per next 100m<sup>2</sup>. Holes must be drilled dry and perpendicular (90°), do not use water for cooling or lubrication.

When drying is from the top only, it is recommended that the hole should be drilled to approx 40% of the slab thickness.

When drying is from both sides, it is recommended that the slab should be drilled to approx 20% of slab thickness.

A hole cleaning brush is often required to ensure the drilled hole is free from any loose particles. A vacuum should also be used to ensure the drilled hole is free from any dust.

The user should always refer to national standard guidelines for definitive and current procedure and specifications.

When performing moisture testing of concrete it is important to get the most accurate and most useful data from the tests. For this reason Tramex recommends a two-pronged approach.

- The first step is to carry out a non-invasive moisture test with the Tramex Concrete Moisture Encounter CME5 or CMEX5. This measures the top section of the concrete slab and gives an average percentage moisture content of the footprint area of the meter. These readings should be used to determine where and how in-situ relative humidity (RH) testing is performed.
- For in-situ RH testing, Tramex recommends that the test holes are drilled, sleeves are placed and capped and left for a period of 24 hours. The probes are then inserted. A suitable equilibration time is allowed before taking readings (see below)
- Tramex recommends that the RH probes are not left in-situ for prolonged periods of time when RH values are above 93%. With the Tramex system it is possible to remove the probe and seal the sleeve for future testing, thus giving a more reliable and accurate test.
- The above recommendations are based on the requirements to prolong the life of the RH probe and to increase the accuracy of the test.

#### **Note: Equilibration Time:**

Allow at least 30 minutes for the probe to reach temperature equilibrium before measuring relative humidity. It is vitally important that the concrete is at the same temperature as the probe

Even a slight difference in temperature will produce a significant error in relative humidity measurement. Check that meter readings do not drift by more than 1% RH over a 5 minute period.

The sensor in the Hygro-i2 probe may take longer to recover if exposed to readings above 93% and can be damaged by prolonged exposure to high humidity.

# HOLE LINER INSTRUCTION

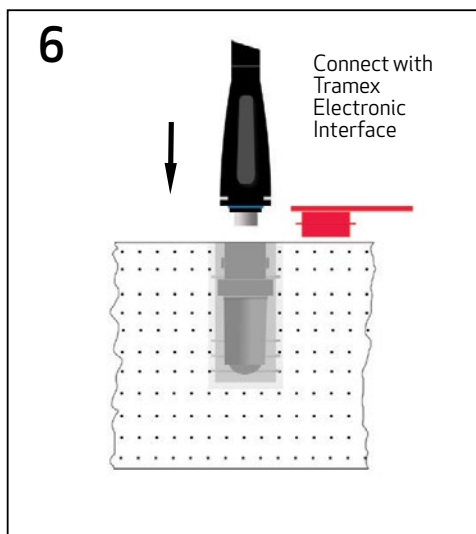
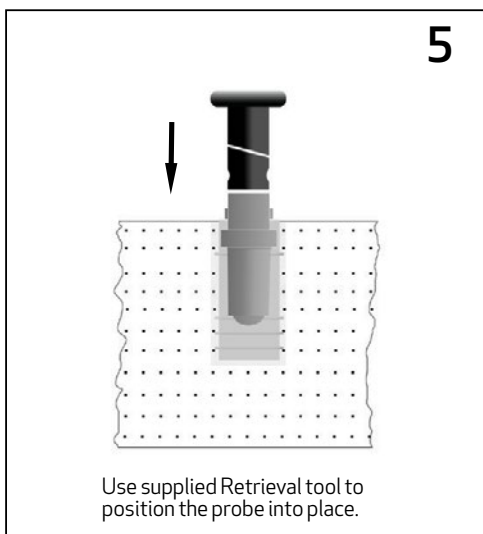
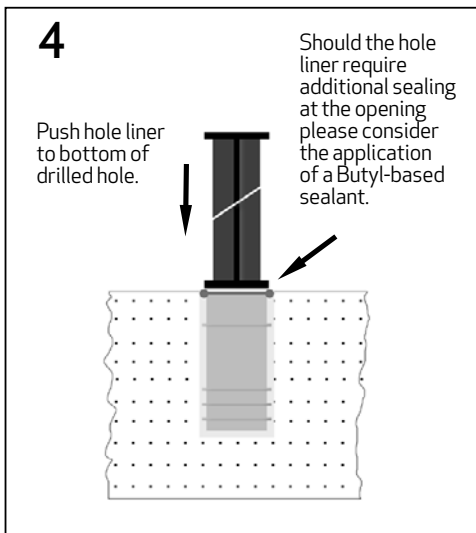
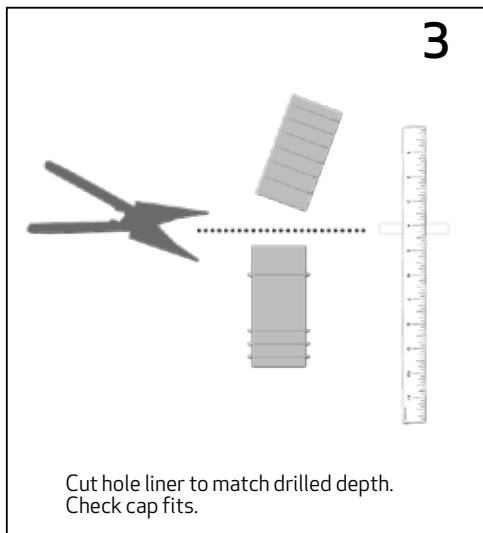
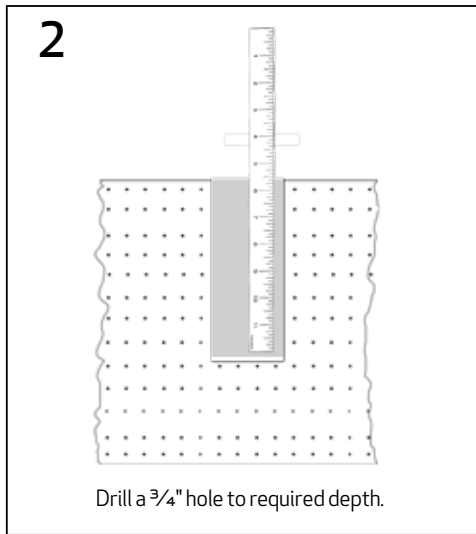
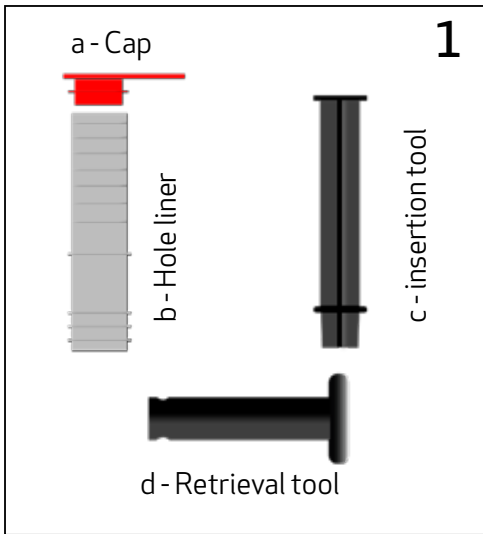

## HOOD INSTRUCTION

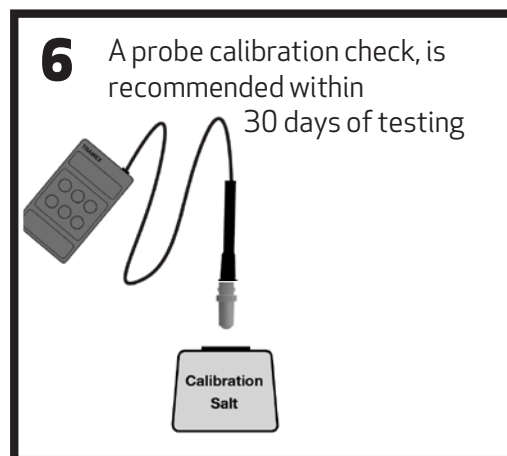
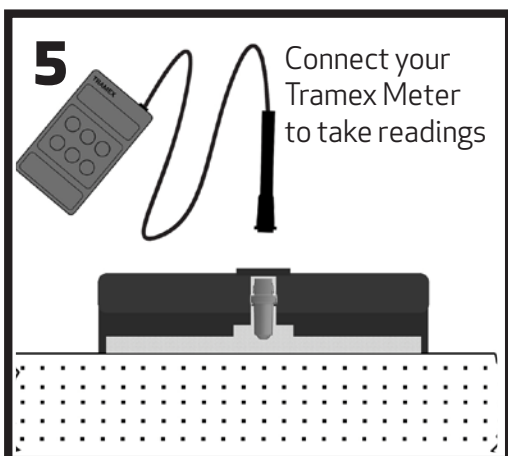
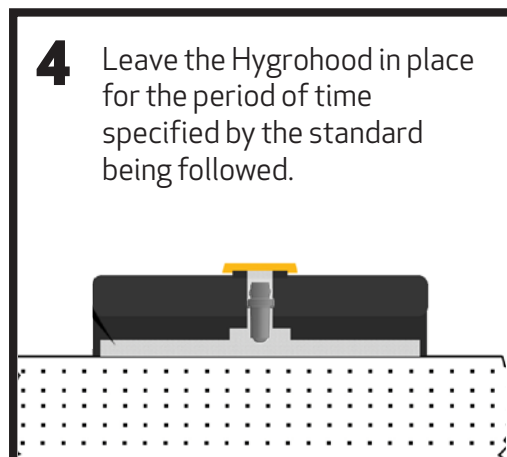
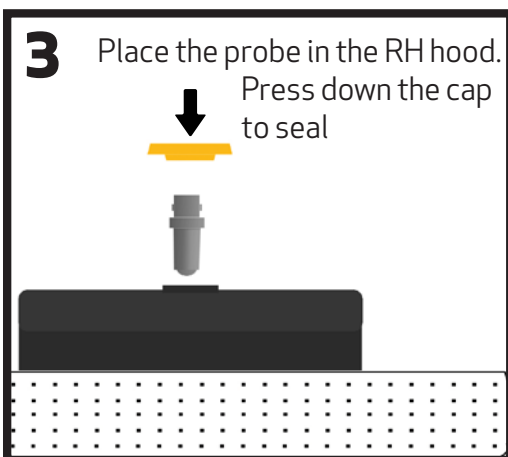
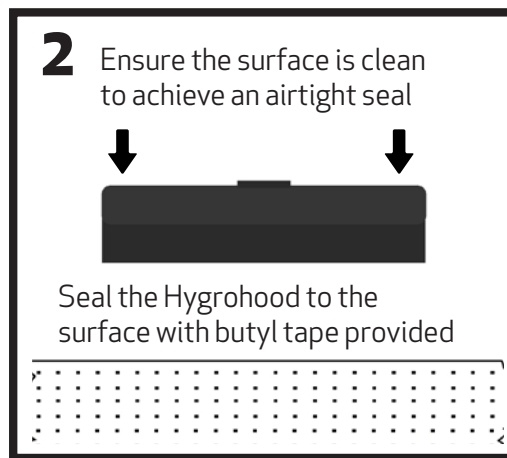

## (b) On Surface RH tests (RH hood method)

The Tramex RH Hood can be used to perform testing to International Standards such as BS 8201, 8203, 5325. The following components are required to perform a RH Hood test: Moisture Encounter X5, a Concrete Moisture Encounter, Insulated hood (RHH), Hygro-i2 probe and interface.

### Pre test guidelines

The Concrete Moisture Encounter CME5 or CMEX5 should be used first in non-invasive mode to give an overall moisture condition of the floor slab. These readings will determine where to position the insulated hood. Careful consideration should be given to the location of the test site. The hood should not be located in direct sunlight or in an area which can be accidentally disturbed. The floor slab surface should be abraded, cleaned of any foreign materials and swept clean of any dust or loose materials that could affect a proper seal between the hood and surface of the floor. The floor should be prepared as specified in the relevant standard.

1. Using a double-sided preformed adhesive/butyl tape, seal the insulated RH hood to the concrete surface.
2. Insert Hygro-i2 probe into the hood using the insertion/retrieval tool.

The sensor in the Hygro-i2 probe may take longer to recover if exposed to readings above 93% and can be damaged by prolonged exposure to high humidity.

3. Please refer to the period of time as specified by the standard being followed for the duration of the test. The user should always refer to national standard guidelines for definitive and current procedures and specifications.
4. When the time period has elapsed, check that meter readings do not drift by more than 1% RH over a 5 min period. Ensure the readings correspond with the floor covering/ adhesive manufacturers' or national standard recommendations before applying floor covering. e.g. British standards code of practice BS8203 suggests that a concrete floor should be sufficiently dry to allow installation of a resilient floor covering when the measured relative humidity falls to 75% or lower using the insulated impermeable box/hood method as specified in the above standard.

Use of artificial aids for accelerated drying of concrete is not recommended. If they are being used it is recommended that they be turned off at least 96 hours before taking final readings.

## CALIBRATION CHECK SALTS

A saturated salt solution is the most suitable method for on-site testing of humidity sensors. The advantage of the on-site salt calibration check is that the user can check that the sensors are performing satisfactorily without having the need to send the sensors to a testing laboratory, which can be expensive and time consuming. The sensors can be checked at a time that is convenient to the user, which means no down time for your equipment. ASTM F2170 requires that humidity probes are checked and readings recorded by the user within 30 days before use. This check can be achieved with a 75% RH saturated Sodium Chloride (NaCl) solution.

### Conditioning of the NaCl calibration check solution and test procedure.

As Relative Humidity (RH) is defined as the ratio of the partial vapor pressure in air to the saturated vapor pressure at a given temperature, it is important to understand that RH strongly depends on temperature. Therefore, it is essential to keep humidity sensors at the same temperature as the air in which the relative humidity is to be measured. When testing RH probes in a calibration check-salt chamber, it is necessary for the internal temperature of the salt chamber to be the same as that of the surrounding air and also the RH probe sensor. This can be achieved by removing the cap and exposing the salt-check solution to ambient conditions. The temperature can be checked with the use of an infrared thermometer. When the probe and solution are showing equal temperature insert the probe into the solution.

The test can be ended when RH% readings do not drift by more than 1% RH over a 5 minute period within the acceptable +/- 2% tolerance of the nominal 75% relative humidity. A temperature difference of +/- 1°C (1.8°F) can cause an error of up to +/-3 to 5% at 50% RH and +/-6% at 97% RH readings. Please note any further handling of the salt chamber can cause a heating effect so handle the salt chamber as little as possible.

Due consideration must also be given to the test site, do not perform in direct sunlight or close to sources of heat eg. heaters or spotlights.

Temperature stability is extremely important for the duration of the test.

Calibration check salts do not have an expiry date and have unlimited usage when cared for in the correct manner.

Check if the seal inside the chamber is exposing as much of the vent as possible and that there is a mix of salt and water and no caking of salt to side walls of the chamber.

Humidity probes exposed to conditions outside normal range, especially high humidity may temporarily offset the RH reading. After returning to normal ambient condition it will slowly return towards the calibration state by itself. Prolonged exposure to extreme conditions may accelerate aging.

For further information please refer to the latest calibration check salt instructions which are supplied separately.

## LIMITATIONS

The Moisture Encounter MEX5 will not detect or measure moisture through any electrically conductive materials including metal sheeting or cladding, many types of black EPDM rubber or wet surfaces. The Moisture Encounter MEX5 is not suited for taking comparative readings in the concrete substrate through thick floor coverings such as wood.

## CALIBRATION

For regular on-site assessment of your Moisture Encounter MEX5 in moisture measurement mode, a calibration-check box is available from the suppliers of your Moisture Encounter MEX5. Should it be found that readings are outside the set tolerances, it is recommended that the Moisture Encounter MEX5 be returned for re-calibration. Calibration adjustments should not be carried out by anyone other than Tramex or their authorized service provider who will issue a calibration certificate on completion. Requirements for quality management and validation procedures, such as ISO 9001, have increased the need for regulation and verification of measuring and test instruments. It is therefore recommended that calibration of the Moisture Encounter MEX5 should be checked and certified in accordance with the standards and/or protocols laid down by your industry (usually on an annual basis) by an authorized test provider. The name of your nearest test provider and estimate of cost is available on request.

## WARRANTY

Tramex warrants that this instrument will be free from defects and faulty workmanship for a period of one year from date of first purchase. If a fault develops during the warranty period, Tramex will, at its absolute discretion, either repair the defective product without charge for the parts and labor, or will provide a replacement in exchange for the defective product returned to Tramex Ltd. This warranty shall not apply to any defect, failure or damage caused by improper use or improper or inadequate maintenance and care.

In no event shall Tramex, its agents or distributors be liable to the customer or any other person, company or organization for any special, indirect, or consequential loss or damage of any type whatsoever (including, without limitation, loss of business, revenue, profits, data, savings or goodwill), whether occasioned by the act, breach, omission, default, or negligence of Tramex Ltd., whether or not foreseeable, arising howsoever out of or in connection with the sale of this product including arising out of breach of contract, tort, misrepresentation or arising from statute or indemnity. Without prejudice to the above, all other warranties, representations and conditions whether made orally or implied by circumstances, custom, contract, equity, statute or common law are hereby excluded, including all terms implied by Section 13, 14 and 15 of the Sale of Goods Act 1893 and Sale of Goods and Supply of Services Act 1980.

## WARRANTY CLAIMS

A defective product should be returned shipping prepaid, with full description of defect to your supplier or to the Tramex at address shown on the back of this guide.



## PRODUCT DEVELOPMENT

It is the policy of Tramex to continually improve and update all its products. We therefore reserve the right to alter the specification or design of this instrument without prior notice.

## SAFETY

This Users Guide does not purport to address the safety concerns, if any, associated with this instrument or its use. It is the responsibility of the user of this instrument to establish appropriate safety and health practices and determine the applicability of regulatory limitations prior to use.

## SPECIES CORRECTION CHART

<i>Meter reading (% moisture content)</i>	7	8	9	10	11	12	13	14	15	16	17	18	19	20	21	22	23	24	
<i>Species</i>	<i>Correct moisture content</i>																		
Alder, brown	9	10	10	11	12	13	13	14	15	15	16	17	18	18	19	20	20	21	21
Amberoi	7	7	8	9	9	10	11	12	12	13	14	14	15	16	17	17	18	19	19
Ash, alpine	9	10	11	12	13	14	15	16	17	18	18	19	20	21	22	23	24	25	25
Ash, American	9	10	11	11	12	13	14	14	15	16	17	18	19	20	21	23	24	25	25
Ash, Crow's	9	10	10	11	12	12	12	14	14	15	16	17	17	18	19	20	20	21	21
Ash, European	8	9	10	11	12	12	13	14	14	15	16	17	18	18	19	20	21	21	21
Ash, mountain	9	10	11	12	13	14	15	16	17	18	18	19	20	21	22	23	24	25	25
Ash, silvertop	5	6	7	8	9	10	11	12	13	14	15	16	17	18	19	20	21	22	22
Balsa	7	8	9	10	11	12	13	14	15	16	17	18	19	20	21	22	23	24	24
Baltic, red	9	10	11	12	13	14	15	15	16	17	18	18	19	20	21	22	23	24	24
Baltic, white	9	10	11	12	13	14	15	16	17	18	19	20	22	23	24	25	26	27	27
Bauvudi	7	8	9	9	10	11	11	12	13	13	14	15	15	16	17	17	18	18	18
Bean, black	9	10	11	12	13	14	15	16	16	17	18	19	20	21	22	23	24	25	25
Beech, American	7	8	10	11	12	13	14	15	16	13	18	19	20	21	23	23	24	25	25
Beech, Japan	8	9	10	11	12	13	14	15	16	17	18	19	20	21	22	23	24	25	25
Beech, myrtle	8	9	10	11	11	12	13	14	14	15	16	17	18	18	19	20	21	22	22

<i>Meter reading (% moisture content)</i>	7	8	9	10	11	12	13	14	15	16	17	18	19	20	21	22	23	24	
<i>Species</i>	<i>Correct moisture content</i>																		
Beech, silver	9	10	10	11	12	12	13	13	14	14	15	16	16	17	17	18	19	19	
Beech, Wau	9	11	12	13	14	15	16	17	18	19	20	21	22	23	24	25	26	27	
Beech, white	8	9	10	11	12	13	14	14	15	16	17	18	19	19	20	21	22	23	
Birch, European	7	8	10	11	12	13	14	15	16	17	18	19	20	21	22	23	24	25	
Birch, white	9	10	11	12	12	13	14	15	15	16	17	18	18	19	20	21	22	22	
Blackbutt	8	9	10	11	12	13	14	15	16	17	18	19	20	21	22	23	24	25	
Blackbutt, WA	9	10	11	12	12	13	14	15	16	17	18	19	20	21	22	23	24	25	
Blackwood	9	9	10	11	12	12	13	14	15	16	16	17	18	19	20	20	21	22	
Bloodwood, red	10	10	11	12	13	14	15	15	16	17	18	19	19	20	21	22	23	23	
Bollywood	7	8	9	10	11	12	12	13	14	15	16	16	17	18	19	20	21	22	
Box, brush	7	7	8	8	9	9	10	10	11	11	12	13	13	14	14	15	15	16	
Box, grey	10	11	12	12	13	14	14	15	16	17	17	18	19	20	20	21	22	23	
Box, grey, coast	9	10	11	11	12	13	14	14	15	16	17	18	18	19	20	21	22	22	
Box, kanuka	8	9	10	11	12	12	13	14	15	16	16	17	18	19	20	20	21	22	
Brownbarrel	7	8	9	10	11	12	12	13	14	15	16	17	18	18	19	20	21	22	

<i>Meter reading (% moisture content)</i>	7	8	9	10	11	12	13	14	15	16	17	18	19	20	21	22	23	24	
<i>Species</i>	<i>Correct moisture content</i>																		
Buchanania	6	7	8	9	10	10	11	12	13	14	14	15	16	17	18	19	19	20	
Candlenut	5	8	10	12	14	16	18	21	23	25	27	29	31	34	36	38	40	42	
Carabeen, yellow	8	9	9	10	11	12	12	13	14	14	15	16	16	17	18	18	19	20	
Cedar, red	9	10	11	12	13	14	16	17	18	19	20	21	22	23	25	26	27	27	
Cedar, red, western	7	9	10	11	12	13	13	14	15	17	18	19	20	21	22	23	24	25	
Cedar, South American	9	10	11	12	13	13	14	15	16	17	17	18	19	20	21	22	22	23	
Cherry	7	8	9	11	12	13	14	15	16	17	18	18	20	21	22	23	21	25	
Cherry, Brazilian	7	8	9	11	12	13	14	15	16	17	18	18	20	21	22	23	21	25	
Coachwood	6	7	8	9	10	11	12	13	14	14	15	16	17	18	19	20	21	22	
Dakua salusalu	9	10	11	11	12	13	14	15	16	17	18	19	19	20	21	22	23	24	
Douglas Fir	7	8	9	10	11	12	13	14	15	16	17	18	19	20	21	22	23	24	
Elm	6	7	7	8	9	10	12	13	13	14	15	15	16	17	18	19	20	20	
Erima	8	8	9	10	11	12	12	13	14	15	15	16	17	18	19	19	20	21	
Fir, Alpine	8	9	10	11	12	13	14	15	16	17	18	19	20	21	22	23	24	25	
Fir, amabilis	8	9	10	11	12	13	14	15	16	17	18	19	20	21	22	23	24	25	
Fir, red	8	9	10	11	12	13	14	15	16	17	18	19	20	21	22	23	25	26	

<i>Meter reading (% moisture content)</i>	7	8	9	10	11	12	13	14	15	16	17	18	19	20	21	22	23	24	
<i>Species</i>	<i>Correct moisture content</i>																		
Fir, white	8	9	10	11	12	13	14	15	16	17	18	19	20	21	22	23	25	26	26
Gum, blue, southern	9	10	11	12	13	14	15	15	16	17	18	18	19	20	21	22	23	24	24
Gum, blue Tasmanian	8	9	10	11	12	12	13	14	15	16	17	17	18	19	20	21	22	22	22
Gum, grey	8	8	9	10	11	12	13	14	15	16	17	18	19	20	21	22	23	24	24
Gum, grey, mountain	9	9	10	11	12	13	14	14	15	16	17	18	19	19	20	21	22	23	23
Gum, lemon-scented	6	7	8	9	10	10	11	12	13	13	14	15	16	17	17	18	19	20	20
Gum, Maiden's	10	11	11	12	13	14	15	16	16	17	18	19	20	20	21	22	23	24	24
Gum, manna	7	7	8	9	10	11	12	13	14	14	15	16	17	18	19	20	21	21	21
Gum, mountain	6	7	8	9	10	11	12	13	14	15	16	17	18	19	20	21	22	23	23
Gum, American, red	10	11	12	12	13	14	15	16	17	18	18	19	20	21	22	23	24	24	24
Gum, red, river	10	11	12	13	14	15	16	17	18	19	20	21	22	23	24	25	26	27	27
Gum, rose	9	10	11	12	13	14	14	15	16	17	18	18	19	20	21	22	23	24	24
Gum, shining	8	9	10	11	11	12	13	14	15	16	17	18	19	20	20	21	22	23	23
Gum, yellow	9	10	11	12	12	13	14	15	15	16	17	18	18	19	20	21	21	22	22

<i>Meter reading (% moisture content)</i>	7	8	9	10	11	12	13	14	15	16	17	18	19	20	21	22	23	24		
<i>Species</i>	<i>Correct moisture content</i>																			
Hemlock, western	8	9	10	11	12	13	15	16	17	18	19	20	21	22	23	24	26	27		
Hickory	-	7	9	11	13	14	16	17	18	20	21	22	24	-	-	-	-	-	-	
Iroko	7	7	8	9	10	11	12	13	14	15	15	16	17	18	19	19	20	21	21	
Ironbark, red	11	12	12	13	14	15	16	17	18	19	20	21	22	22	22	23	24	24	24	24
Ironbark, red, broad-leaved	11	12	12	13	14	15	16	17	18	19	20	21	22	22	22	23	24	24	25	25
Ironbark, red, narrow-leaved	8	9	10	11	12	13	14	14	15	16	17	18	19	20	21	22	23	24	24	24
Jarrah	8	9	10	11	12	13	14	15	16	17	18	19	20	21	22	23	24	25	25	25
Jelutong	8	9	10	11	12	12	13	14	15	16	16	17	18	19	20	21	21	21	22	22
Kamarere (PGN source)	8	9	10	10	11	12	13	14	15	16	17	18	19	19	20	21	22	23	23	23
Kamarere (Fiji source)	7	8	8	9	10	11	11	12	13	13	14	15	15	16	17	17	18	19	19	19
Kapur	7	8	9	10	11	12	13	14	15	16	17	18	19	20	21	22	23	24	24	24
Karri	7	8	9	10	11	12	13	13	14	15	16	17	18	19	20	21	22	23	24	24
Kauri, Qld	10	11	12	13	14	15	16	16	17	18	19	20	21	22	23	24	24	25	25	25
Kauri, NZ	9	10	10	11	12	12	13	13	14	14	15	16	16	17	17	18	18	19	19	19
Kauri, Vanikoro	11	12	13	13	14	14	15	15	16	16	17	17	18	18	18	19	19	19	19	19

<i>Meter reading (% moisture content)</i>	7	8	9	10	11	12	13	14	15	16	17	18	19	20	21	22	23	24	
<i>Species</i>	<i>Correct moisture content</i>																		
Kempas	8	9	10	12	13	14	15	16	17	18	19	20	21	22	23	24	25	26	
Laran	8	8	9	10	11	11	12	13	14	15	16	17	18	19	20	21	22	23	
Larch, European	8	9	10	11	12	13	14	15	16	17	18	19	20	21	22	23	24	25	
Lodgepole Pine	7	8	9	10	12	13	14	15	16	17	18	19	20	21	22	23	24	25	
Lumbayau	8	9	10	11	12	12	13	14	15	16	17	18	19	20	21	22			
Mahogany, African	10	11	12	13	14	15	16	17	18	19	20	21	22	23	24	25	26	27	
Mahogany, American	7	8	9	10	11	12	13	14	15	16	17	18	19	20	21	22	23	24	
Mahogany, Brazilian	-	-	-	10	10	11	12	13	14	15	16	17	18	19	20	21	22		
Mahogany, brush	8	9	10	10	11	11	12	12	13	14	14	15	15	16	16	17	18	18	
Mahogany, miva	10	11	12	12	13	14	15	16	17	18	19	20	21	22	23	24	25	26	
Mahogany, red	10	11	12	13	14	15	16	17	18	19	20	21	22	23	24	25	26		
Mahogany, rose	9	10	10	11	12	12	13	14	15	16	17	18	19	20	21	22	23	24	
Mahogany, santos	8	9	10	12	13	14	15	16	17	18	19	20	21	22	23	24	25	26	
Mahogany, southern	8	9	10	11	12	12	13	14	15	16	17	18	19	20	20	21	22	23	
Mahogany, Honduras	7	7	8	9	10	11	12	13	14	15	16	17	18	19	19	20	21	22	
Mahogany, white	9	10	11	12	13	14	15	16	17	18	19	20	21	22	23	24	25	26	
Makoré	9	10	11	12	13	14	15	16	17	18	19	20	21	22	23	24			
Malas	7	8	9	9	10	11	12	13	14	15	16	17	18	19	20	21	22	23	

Meter reading (% moisture content)	7	8	9	10	11	12	13	14	15	16	17	18	19	20	21	22	23	24	
<i>Species</i>	<i>Correct moisture content</i>																		
Maple, Canadian	7	8	9	10	11	12	13	14	15	16	17	18	18	20	21	22	23	24	24
Maple, Qld	10	10	11	12	13	14	15	16	17	18	18	19	20	21	22	23	24	24	24
Maple, rose	8	8	9	10	10	11	12	12	13	14	14	15	16	16	17	18	18	19	19
Maple, sugar	7	7	8	10	12	13	14	15	16	17	18	19	20	21	22	23	24	-	-
Mararie	10	11	11	12	13	14	14	15	16	17	18	18	19	20	21	21	22	23	23
Marri	7	8	9	9	10	11	11	12	13	13	14	15	15	16	17	17	18	18	19
Matai	9	9	10	11	12	12	13	14	15	16	16	17	18	18	19	20	21	22	22
Meranti	7	8	9	10	11	12	13	14	13	16	17	18	19	20	21	22	23	24	24
Messmate	10	11	12	12	13	14	15	16	16	17	18	18	19	20	21	22	22	23	23
Nutmeg (Fiji source)	7	8	9	10	11	11	12	13	14	14	15	16	17	18	18	19	20	21	21
Oak, American red	7	8	9	11	12	13	14	15	16	17	18	18	20	21	22	23	21	25	25
Oak, European	7	8	9	10	11	12	13	14	15	16	17	18	19	21	22	23	24	25	25
Oak, New Guinea	7	8	9	10	11	12	13	14	15	16	17	18	19	20	21	22	23	24	24
Oak, silky, northern	8	8	9	10	11	12	13	14	15	16	17	17	18	19	20	21	22	23	23
Oak, silky, red	8	9	9	10	11	11	12	13	13	14	15	16	16	17	18	18	19	20	20
Oak, silky, southern	7	10	10	11	12	13	14	15	16	17	18	19	20	21	22	23	24	25	25
Oak, tulip, blush	7	11	12	12	13	14	15	16	16	17	18	19	20	21	22	23	24	25	25



Meter reading (% moisture content)	7	8	9	10	11	12	13	14	15	16	17	18	19	20	21	22	23	24	
<i>Species</i>	<i>Correct moisture content</i>																		
Oak, tulip, brown	10	11	12	12	13	13	14	14	15	16	16	17	18	18	19	19	20	20	
Oak, tulip, red	11	12	13	14	15	16	17	18	18	19	20	21	22	23	24	25	25	26	
Oak, white	6	7	8	9	10	11	12	13	14	15	16	17	18	18	19	20	21	22	
Obeche	7	8	9	10	10	1	12	13	14	15	15	16	16	17	18	18	19	20	
Padauk, African	7	7	8	9	10	11	12	13	14	15	15	16	17	18	19	19	20	21	
Peppermint, broad-leaved	9	10	11	12	13	14	15	16	17	18	19	20	21	22	23	24	25	26	
Peppermint, narrow-leaved	10	11	11	12	13	14	14	15	16	17	18	18	19	20	21	22	22	23	
Persimmon	7	8	9	10	10	11	12	13	14	15	15	16	16	17	18	18	19	20	
Pine, bunya	10	11	12	12	13	14	14	15	16	16	17	18	18	19	20	21	21	22	
Pine, Corsican	9	10	11	12	13	14	15	16	17	18	19	20	22	23	24	25	26	27	
Pine, cypress, white	9	10	11	11	12	13	14	15	17	17	18	19	20	21	22	22	23	24	
Pine, hoop	10	11	11	12	13	14	15	16	17	17	18	19	20	21	22	22	23	24	
Pine, Huon	10	10	12	12	13	13	14	15	15	16	17	18	18	19	20	20	21	22	
Pine, King William	9	9	11	12	12	13	14	14	15	16	16	17	18	18	19	20	20	21	

Meter reading (% moisture content)	7	8	9	10	11	12	13	14	15	16	17	18	19	20	21	22	23	24	
<i>Species</i>	<i>Correct moisture content</i>																		
Pine, klinki	7	8	9	10	11	12	13	14	15	16	17	18	19	20	21	22	23	24	
Pine, longleaf	9	10	11	12	13	14	15	16	17	18	19	20	22	23	24	25	26	27	
Pine, lodgepole	7	9	10	11	12	13	14	15	16	17	18	19	20	21	22	23	24	25	
Pine, maritime	10	11	12	12	13	14	15	16	17	18	19	20	21	22	23	24	25	26	
Pine, white, NZ	-	-	-	11	12	12	13	14	15	16	17	18	19	20	21	22	23	24	
Pine, Parana	7	8	9	10	11	12	13	14	15	16	17	18	19	20	21	22	23	24	
Pine, ponderosa	7	9	10	11	13	14	15	16	17	18	19	20	21	22	22	23	24	25	
Pine, radiata	10	11	11	12	13	14	15	16	17	18	19	20	21	22	24	25	26	27	
Pine, scots/shortleaf	7	9	10	11	12	13	14	15	16	17	18	19	20	21	22	23	24	25	
Pine, slash	8	9	10	11	12	13	14	15	16	17	17	18	19	20	21	22	23	24	
Pine, sugar	8	9	10	11	12	13	14	15	16	17	18	20	21	22	23	24	25	26	
Pine, white, western	-	8	9	10	11	11	12	13	14	15	16	17	17	18	19	20	21	22	
Poplar	7	9	10	11	12	13	14	15	16	17	18	19	20	21	22	23	24	25	
Quandong, silver	7	8	9	10	10	11	12	12	13	14	14	15	16	16	17	18	18	19	
Redwood	9	9	10	11	12	13	14	15	16	16	17	18	19	20	20	21	22	23	

<i>Meter reading (% moisture content)</i>	7	8	9	10	11	12	13	14	15	16	17	18	19	20	21	22	23	24	
<i>Species</i>	<i>Correct moisture content</i>																		
Redwood, European	7	9	10	11	12	13	14	15	16	17	18	19	20	21	22	23	24	25	
Rosewood, Patagonian	8	9	10	12	13	14	15	16	17	18	19	20	21	22	23	24	25	26	
Rosewood, Tiete	8	9	10	12	13	14	15	16	17	18	19	20	21	22	23	24	25	26	
Rosarosa	8	9	10	10	11	12	13	13	14	15	15	16	17	18	18	19	-	-	
Sapele	9	10	11	12	13	14	15	16	17	18	19	20	22	23	24	25	26	27	
Sassafras	8	9	10	10	11	12	13	13	14	15	16	16	17	18	18	19	20	21	
Sassafras, southern	9	10	11	11	12	13	13	14	15	15	16	17	17	18	19	19	20	21	
Satinash, grey	8	9	9	10	11	12	13	14	15	16	16	17	18	19	20	21	22	23	
Satinash, New Guinea	7	8	8	9	10	11	11	12	13	13	14	15	16	16	17	18	19	19	
Satinash, rose	7	7	8	8	9	10	10	11	12	12	13	13	14	15	16	16	-	-	
Satinay	7	8	9	10	11	12	13	14	15	16	17	18	19	20	21	22	23	24	
Satinheart, green	9	10	10	11	11	12	12	13	13	14	14	15	15	16	16	17	-	-	
Sepetir	8	9	10	12	13	14	15	16	17	18	20	21	22	23	24	25	26	27	
Sheoak, river	8	9	10	10	11	11	12	12	13	14	14	15	16	16	17	17	18	-	
Sheoak, rose	9	10	11	11	12	13	13	14	14	15	15	16	16	17	18	18	19	19	
Sheoak, WA	9	10	11	11	12	12	13	14	14	15	16	16	17	18	18	19	20	20	
Silkwood, bolly	9	10	11	11	12	12	13	13	14	14	15	15	16	16	17	17	18	18	

Meter reading (% moisture content)	7	8	9	10	11	12	13	14	15	16	17	18	19	20	21	22	23	24	
Species	Correct moisture content																		
Silkwood, red	6	7	7	8	9	10	10	11	12	12	13	14	14	15	16	17	17	18	
Silkwood, silver	9	10	11	12	12	13	14	15	15	16	17	18	18	19	20	20	21	22	
Spruce, Sitka	7	8	9	11	11	12	13	15	16	17	18	19	20	21	22	23	25	26	
Spruce, western white	7	8	10	11	12	13	14	15	16	17	18	19	20	21	21	23	24	25	
Stringybark, brown	9	10	11	11	12	13	14	15	16	17	18	19	19	20	21	22	23	24	
Stringybark, Darwin	8	8	9	10	11	12	13	14	15	15	16	17	18	19	20	21	22	22	
Stringybark, yellow	11	12	13	14	14	15	16	17	18	18	19	20	21	21	22	23	24	24	
Sycamore	7	7	8	9	10	11	12	13	14	15	15	16	17	18	19	19	20	21	
Sycamore, satin	9	9	10	11	11	12	12	13	14	14	15	16	16	17	18	18	19	20	
Sycamore, silver	9	10	10	11	12	12	13	13	14	14	15	16	16	17	17	18	19	19	
Tallowwood	7	8	9	10	11	12	13	14	15	16	17	18	19	20	21	22	23	24	
Tawa	9	10	10	11	11	12	12	13	13	14	14	15	15	16	16	17	17	18	
Teak, Brazilian	8	9	10	12	13	14	15	16	17	18	19	20	21	22	23	24	25	26	
Teak	7	7	8	9	10	11	12	13	14	14	15	15	16	16	17	18	19	20	
Tigerwood	10	11	12	13	14	15	16	17	18	19	20	21	22	23	24	25	26	27	
Tingle, red	9	10	11	12	13	15	16	17	18	19	21	22	23	24	25	27	28	29	
Tingle, yellow	9	10	11	12	13	14	15	17	18	19	20	21	22	23	25	26	27	28	

<i>Meter reading (% moisture content)</i>	7	8	9	10	11	12	13	14	15	16	17	18	19	20	21	22	23	24	
<i>Species</i>	<i>Correct moisture content</i>																		
Totara	8	9	10	10	11	12	12	13	14	14	15	16	16	17	18	18	19	19	
Touriga, red	11	11	12	13	14	14	15	16	17	17	18	19	20	20	21	22	23	23	
Tuart	9	10	11	12	12	13	14	15	15	16	17	17	18	19	20	20	21	22	
Turpentine	8	9	10	11	12	13	14	15	16	17	18	19	20	21	22	23	24	24	
Vitex, New Guinea	8	8	9	10	11	12	13	13	14	15	16	17	18	18	19	20	21	22	
Walnut, African	10	11	12	13	14	15	16	17	18	19	20	21	22	23	24	25	26	27	
Walnut, American Black	8	9	10	12	13	14	15	16	17	18	19	20	21	22	23	24	25	26	
Walnut, Brazilian	8	9	10	12	13	14	15	16	17	18	19	20	21	22	23	24	25	26	
Walnut, bluish	10	11	12	12	13	14	14	15	16	16	17	18	18	19	19	20	21	21	
Walnut, European	9	10	11	12	13	14	15	16	17	18	19	20	22	23	24	25	26	27	
Walnut, New Guinea	7	8	9	10	11	12	13	14	15	16	17	17	18	19	20	-	-	-	
Walnut, Peruvian	7	8	9	11	12	13	14	15	16	17	18	18	20	21	22	23	21	25	
Walnut, Qld	9	10	11	12	13	14	15	16	17	18	19	20	22	23	24	25	25	27	
Walnut, yellow	7	8	8	9	10	10	11	12	12	13	14	14	15	16	17	17	18	19	
Wandoo	10	11	12	13	14	15	16	16	17	18	19	20	21	22	23	24	25	25	
Wattle, bicory	8	9	10	11	11	12	13	13	14	14	15	16	16	17	18	18	19	20	
Wattle, silver	9	10	10	11	12	13	13	14	15	16	16	17	18	19	20	20	21	22	
Western Hemlock	7	9	10	11	12	13	14	15	16	17	18	19	20	21	22	23	24	25	
Western red spruce	7	9	10	11	12	13	14	15	16	17	18	19	20	21	22	23	24	25	
Wollybutt	10	10	11	12	13	14	15	15	16	17	18	19	20	20	21	22	23	24	

www.tramexmeters.com

FIND US ON:



---

Tramex Ltd.  
Unit F, Glencormack Business Park,  
Kilmacanogue,  
County Wicklow, Ireland.

Email: [sales@tramexmeters.com](mailto:sales@tramexmeters.com)

USA (toll free) & Canada:  
Tel: 1800-234-5849

EU & Rest Of World:  
Tel: +353 1 681 4450